

NKX45-XL

Needle roller/axial ball bearing

Schaeffler ID:
0506052400000

Needle roller/axial ball bearings NKX, axial component, single direction, to DIN 5429, without end cap, for oil lubrication

X-life

Technical information

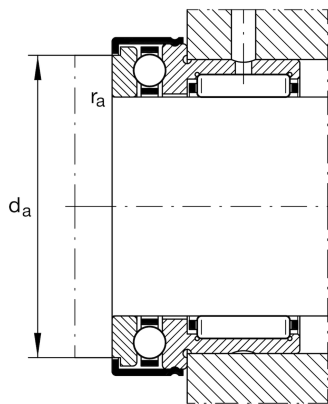
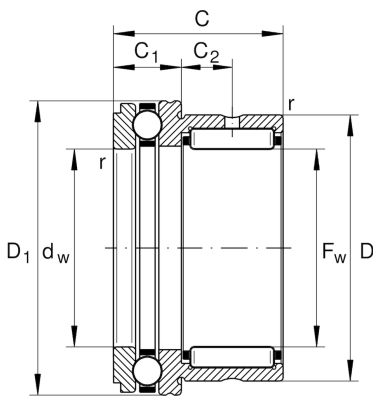

Main Dimensions & Performance Data

F_w	45 mm	Bore diameter
D	58 mm	Outside diameter
C	32 mm	Height
C_r	31,000 N	Basic dynamic load rating, radial
C_{0r}	53,000 N	Basic static load rating, radial
C_a	28,000 N	Basic dynamic load rating, axial
C_{0a}	69,000 N	Basic static load rating, axial
C_{ur}	9,400 N	Fatigue load limit, radial
C_{ua}	3,400 N	Fatigue load limit, axial
n_G	3,600 1/min	Limiting speed
	247.39 g	Weight

Dimensions

$D_{1 \max}$	65.2 mm	Maximum outside diameter flange
	IR40X45X20-XL	Suitable inner rings IR
$D_{2 \max}$	65.2 mm	Maximum outside diameter flange
C_1	14 mm	Width of the axial bearing component
C_1	9 mm	Distance to lubrication hole
C_2	9 mm	Distance to lubrication hole
d_w	45 mm	Bore diameter of shaft washer
r_{\min}	0.6 mm	Minimum chamfer dimension

Mounting dimensions

d_a	60.5 mm	Mounting dimension shaft shoulder
$r_{a \max}$	0.6 mm	Maximum recess radius

Temperature range

T_{\min}	-30 °C	Operating temperature min.
T_{\max}	120 °C	Operating temperature max.